

BRECO *flex* CO., L.L.C.

High Precision Drive Components



B216

PULLEYS FOR POLYURETHANE AND NEOPRENE TIMING BELTS

PULLEYS FOR TIMING BELTS

BRECOflex CO., L.L.C. PULLEY MANUFACTURING

The only domestic source for perfect meshing timing belts and pulleys

BRECOflex CO., L.L.C., the pioneer and world leader in the polyurethane timing belt industry, is offering a wide range of finished precision metal pulleys, as well as high precision timing belts to meet the highest customer expectations.

BRECOflex CO., L.L.C. is proud to announce their new production facility for the domestic manufacture of made-to-order pulleys.

The perfect meshing of *timing belt* and *pulley teeth* is crucial for satisfactory performance and long service life of any belt drive. Therefore, sourcing both timing belts and matching timing pulleys from BRECOflex CO., L.L.C., as your single source provider, is your assurance for perfect belt – pulley performance.

The new “CNC” state of the art pulley manufacture allows for very precise machining standards, leading to superior product quality and quick product availability.

BRECOflex CO., L.L.C. is providing finished precision pulleys made-to-specification and stock pulleys with pilot bores, for immediate delivery. Pulleys are available with normal backlash, reduced backlash “SE” or zero backlash “0” tooth gap design. See page 8 and 9 for details. The pulleys can be flanged as required by the application.

Free application engineering support is available. Log on to our website at www.brecoflex.com for additional information. Also access our belt/pulley calculation program to size your belt drives and download “2D” and “3D” drawings.

BRECOflex CO., L.L.C. is ISO 9001 certified in recognition of its quality management system providing evidence of conformance to the international accepted ISO standards of quality assurance.

PULLEY PITCH RANGE - OVERVIEW

BRECOflex CO., L.L.C. offers a wide range of common pulley pitches.

T-Series

- T 2
- T 2.5
- T 5
- T 10
- T 20

AT-Series

- AT 3
- AT 5
- AT 10
- AT(S) 15
- AT 20

ATN-Series

- ATN 10
- ATN 12.7
- ATN 20

ATL-Series

- ATL 5
- ATL 10
- ATL 20

Imperial-Series

- MXL
- XL
- L
- H
- XH
- XXH

HTD/STD-Series

- HTD 3M
- HTD 5M
- HTD 8M
- HTD 14M
- HTD 20M
- STD S3M
- STD S5M
- STD S8M

Self-Tracking-Series

- TK5 K6
- TK10 K6
- TK10 K13
- TK20 K13
- ATK5 K6
- ATK10 K6
- ATK10 K13
- ATK20 K13

SFAT-Series

- SFAT 10
- SFAT 15
- SFAT 20

ATP-Series

- ATP 10
- ATP 15

ARC-Power-Series

- BAT 10
- BATK 10
- BAT 15
- BATK 15

Contact us for
V-belt pulleys,
flat belt pulleys
and unique
timing belt
pulley pitches.



PULLEYS FOR TIMING BELTS

PULLEYS... MADE-TO-ORDER

- Cutting Edge “CNC” Technology
 - Pulleys Made To Specification



- Lean Manufacturing Company
 - Short Pulley Delivery Time
 - Superior Quality Manufacturing

PULLEYS... MADE-TO-ORDER

- Outstanding Product Performance
 - Domestic Single Source Provider

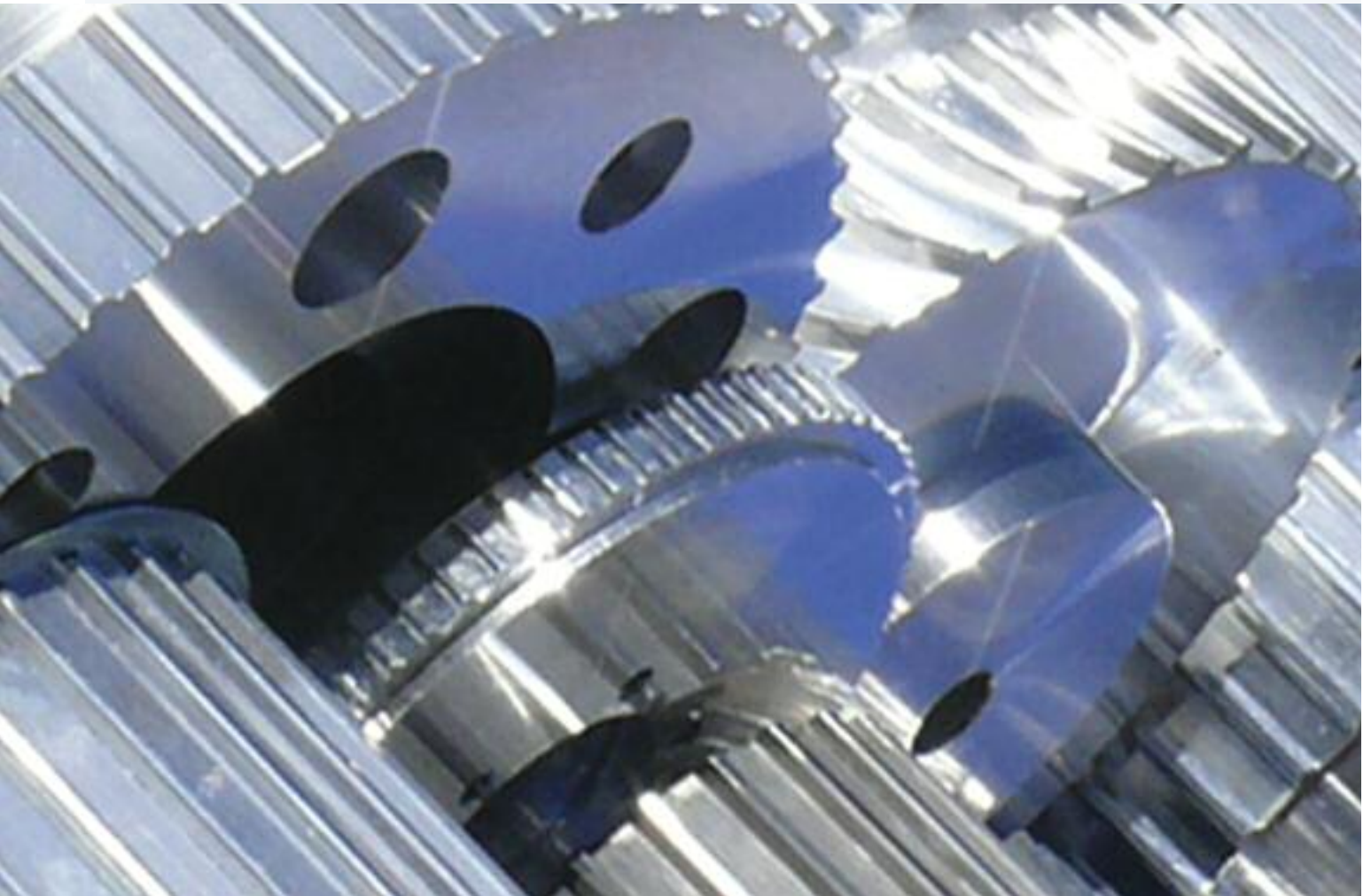

- ISO 9001 Certified Company
 - Prototyping - Short Runs - Production
 - Perfect Meshing of Pulley & Timing Belt

PULLEYS FOR TIMING BELTS

PULLEYS... MADE-TO-ORDER

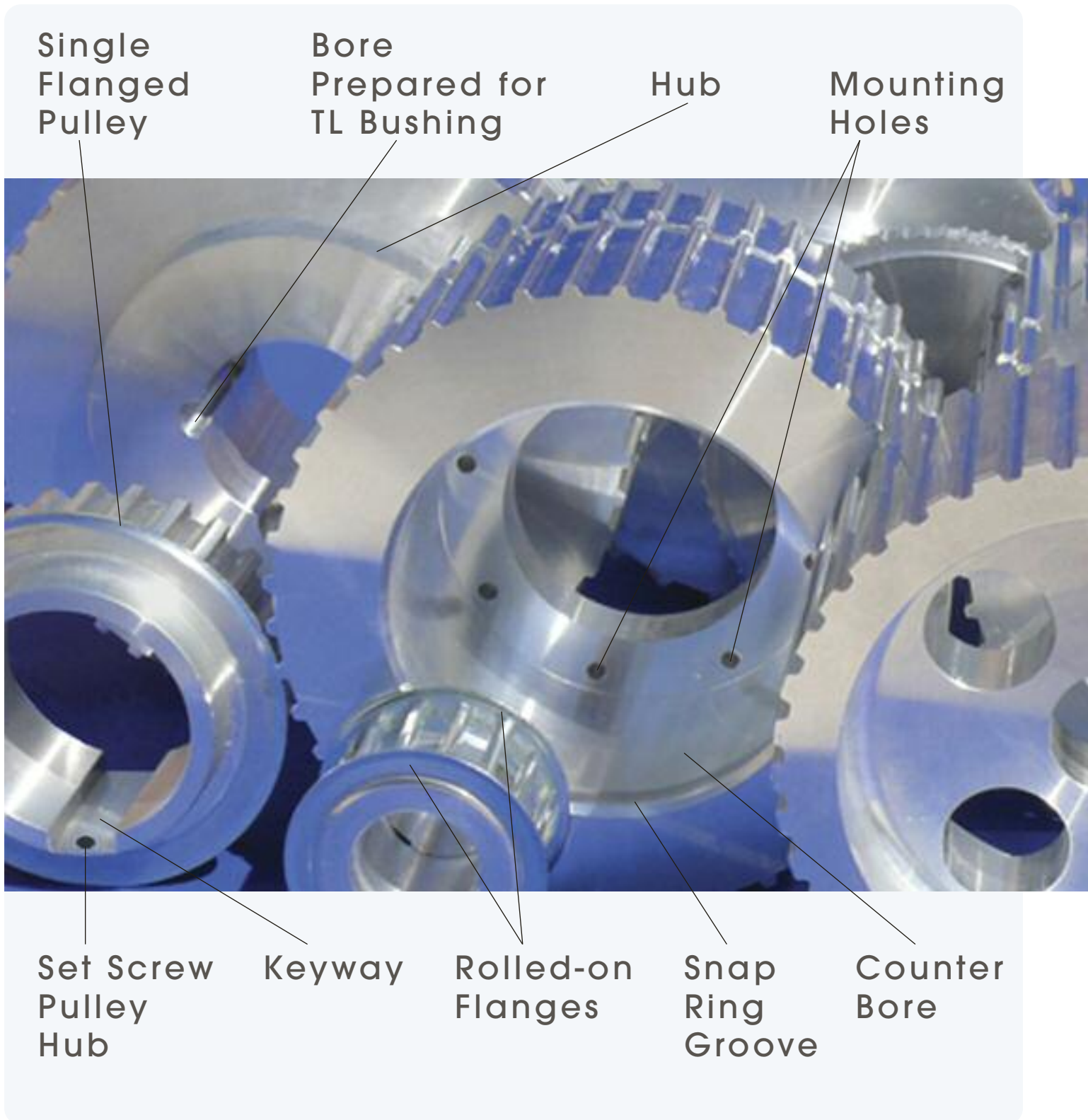

PULLEYS... MADE-TO-ORDER

Set Screw
Pulley
Face

Mounting
Holes

Screwed-on
Flanges

Threaded and
Through Holes
for QD Bushing



Lightening
Holes

Un-Flanged
Pulley

Bolt
Hole
Circle

Self-
Tracking
Groove

Pilot
Bore

PULLEYS FOR TIMING BELTS

PULLEY TOOTH DESIGN – OVERVIEW

Pulley tooth design versions available:

Selecting a special pulley tooth gap can increase the accuracy of the timing belt system by decreasing or eliminating “play” between the timing belt and the pulley. Linear drives and systems requiring precise positioning and high repeatability or fast settling times can benefit from reduced “play”. The illustrations below show the meshing of the timing belt with the tooth gap designs available for metric pitches.

For drive designs using “SE” or “0” – tooth gap pulleys, please consult BRECOflex CO., L.L.C. Engineering Department.

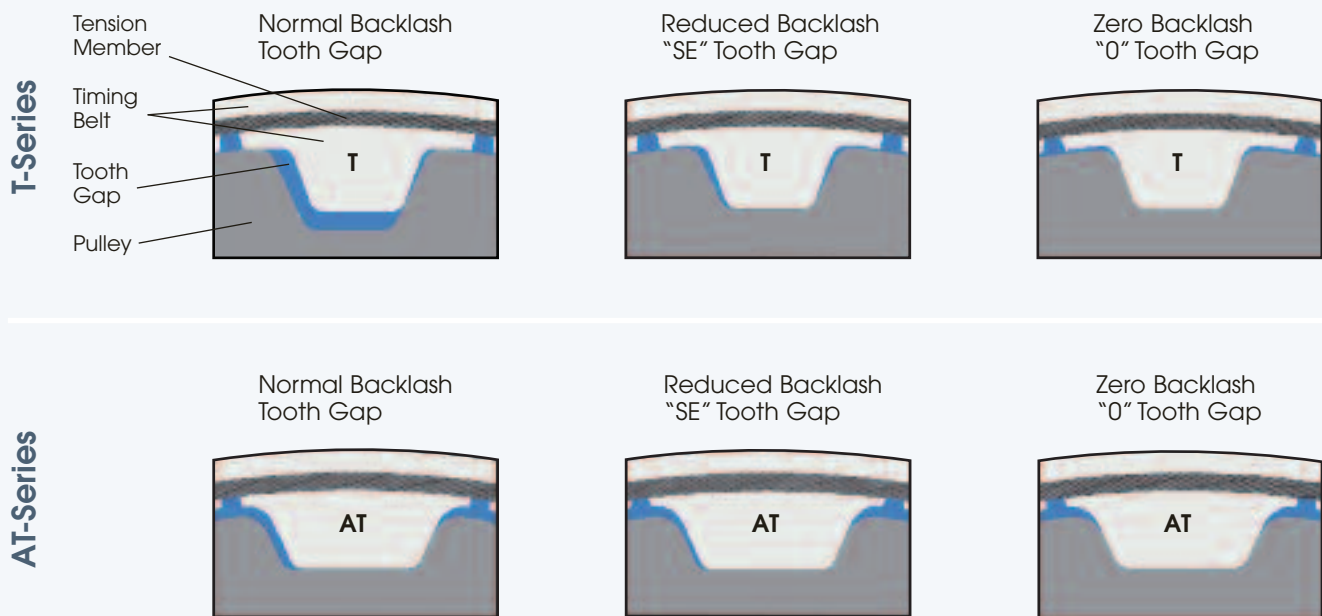

BELT ELEVATION AND CONTACT SURFACE COMPARISON

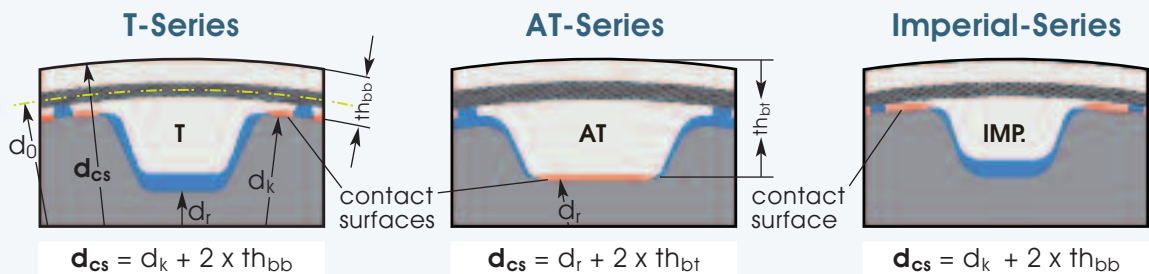

d_{cs} = belt diameter at carrying side
 d_r = pulley root diameter

d_k = pulley outside diameter
 th_{bb} = belt thickness without tooth

th_{bt} = belt thickness including tooth
 d_0 = pitch diameter

STANDARD AND OPTIONAL PULLEY TOOTH DESIGNS

BRECOflex CO., L.L.C. offers three pulley tooth designs for metric pitches as follows:

Normal Backlash

Reduced Backlash "SE"

Zero Backlash "0"

Standard **T**ooth **G**ap **D**esign (T.G.D.) - Standard tooth design will be supplied if no options are specified when ordering.

Optional **T**ooth **G**ap **D**esign (T.G.D.) - Optional tooth design must be specified at the time of ordering, otherwise the standard tooth gap design will be provided.

The charts below shows the standard and optional tooth designs based on the Number of Pulley Teeth.

METRIC T-SERIES and AT20

Tooth Gap Designs	Pulley ≤ 20 teeth	Pulley > 20 teeth
Normal Backlash	"SE" applies as Standard T.G.D.	Standard T.G.D.
Reduced Backlash "SE"	Standard T.G.D.	Optional T.G.D.
Zero Backlash "0"	Optional T.G.D.	

AT-SERIES excluding AT20

Tooth Gap Designs	# of Pulley Teeth "ALL"
Normal Backlash	Standard T.G.D.
Reduced Backlash "SE"	Optional T.G.D.
Zero Backlash "0"	Optional T.G.D.

T-SERIES TOOTH GAP ORDERING EXAMPLES

Normal Backlash

of teeth ≤ 20: AL 40 T10 - **SE** / 18 - 2

of teeth > 20: AL 40 T10 / 24 - 2

For pulleys with < = 20 teeth Reduced Backlash "SE" is standard. Normal Backlash is only available for pulleys with > 20 teeth.

Reduced Backlash "SE"

of teeth ≤ 20: AL 40 T10 - **SE** / 18 - 2

of teeth > 20: AL 40 T10 - **SE** / 24 - 2

Reduced Backlash "SE" is standard for pulleys ≤ 20 teeth. For pulleys > 20 teeth Reduced Backlash "SE" must be specified.

Zero Backlash "0"

of teeth ≤ 20: AL 40 T10 - **0** / 18 - 2

of teeth > 20: AL 40 T10 - **0** / 24 - 2

Zero Backlash "0" must be specified for all pulleys.

AT-SERIES TOOTH GAP ORDERING EXAMPLES

Normal Backlash

of teeth - All: AL 42 AT10 / 24 - 2

Normal Backlash is standard for all pulleys.

Reduced Backlash "SE"

of teeth - All: AL 42 AT10 - **SE** / 24 -2

Reduced Backlash "SE" must be specified for all pulleys.

Zero Backlash "0"

of teeth - All: AL 42 AT10 - **0** / 24 -2

Zero Backlash "0" must be specified for all pulleys.

English pitches are not available as "SE" or "0".

For a pulley ordering example see page 12.

PULLEYS FOR TIMING BELTS

PULLEY MATERIALS

Aluminum (AL)

- Suitable for moderate power transmission
- Light weight / reduced rotational inertia
- Moderate chemical and corrosion resistance
- Standard material for stock pulleys

Stainless Steel (VA)

- Suitable for high power transmission
- Durable / abrasion resistant
- Meets FDA regulations
- Excellent chemical and corrosion resistance

Steel (ST)

- Suitable for high power transmission
- Durable / abrasion resistant
- Limited chemical and corrosion resistance

Delrin (POM)

- Limited power transmission
- Excellent chemical and corrosion resistance
- Non metallic
- Stainless steel flanges recommended

PULLEY FINISHES

Aluminum

Anodized

- Increased chemical and corrosion resistance
- Available in clear, black, or colored
- Limited increase of surface hardness
- Aesthetic treatment

Hard Anodized

- Excellent chemical and corrosion resistance
- Increased surface hardness
- For abrasive environments

Steel

Black Oxide

- Increased chemical and corrosion resistance
- Aesthetic treatment

Zinc plated

- Increased corrosion resistance

Chromate

- Increased chemical and corrosion resistance

Nickel plated

- Increased chemical and corrosion resistance

BELT WIDTH IN RELATION TO PULLEY FACE WIDTH

Metric Pitches





Belt Width (mm)	4	6	8	10	16	20	25	32	50	75	100	150
Flanged/un-flanged pulleys												
Pulley Face Width (mm)	8	12	14	16	22	26	32	40	60	85	110	160
Self-Tracking												
Pulley Face Width (mm)	-	-	-	-	21	25	30	37	55	80	105	155

English Pitches

Belt Width (mm) (inch)	6.35 (.25)	7.94 (.313)	9.53 (.375)	12.7 (.5)	19.1 (.75)	25.4 (1.0)	38.1 (1.5)	50.8 (2.0)	76.2 (3.0)	101.6 (4.0)	152.4 (6.0)
Flanged/un-flanged pulleys											
Pulley Face Width (mm) (inch)	12 (.472)	14 (.551)	16 (.63)	19 (.748)	25 (.984)	32 (1.26)	44 (1.732)	59 (2.323)	84 (3.307)	111 (4.37)	163 (6.417)
Self-Tracking											
Pulley Face Width (mm) (inch)	-	-	-	-	-	30 (1.181)	43 (1.693)	55 (2.165)	80 (3.15)	105 (4.134)	157 (6.181)

PULLEYS FOR TIMING BELTS

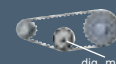
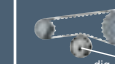
MINIMUM NUMBER OF PULLEY TEETH AND IDLER DIAMETER

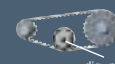
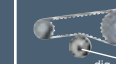
Application Pitch					Application Pitch				
	Min. # of Pulley Teeth (no Back Bending)	Min. # of Pulley Teeth (with Back Bending)	Min. Dia. of Flat Idler Running on Tooth Side (mm)	Min. Dia. of Flat Idler Running on Belt Back (mm)		Min. # of Pulley Teeth (no Back Bending)	Min. # of Pulley Teeth (with Back Bending)	Min. Dia. of Flat Idler Running on Tooth Side (mm)	Min. Dia. of Flat Idler Running on Belt Back (mm)
T 2	10	18	15	15	H	14	20	60	80
T 2.5	15	18	15	18	XH	18	25	150	180
T 5	10	15	30	30	BAT 10	20	25	60	120
T 10	12	20	60	60	BATK 10	20	25	60	120
T 20	15	25	120	120	BAT 15	20	30	100	150
AT 3	15	25	30	30	BATK 15	20	30	100	150
AT 5	15	20	25	60	SFAT 10	15	25	50	120
AT 10	15	25	50	120	SFAT 15	20	25	100	150
AT(S) 15	25	40	120	250	SFAT 20	18	25	120	180
AT 20	18	25	120	180	TK5 K6	25	25	60	80
ATN 10	25	—	80	—	TK10 K6	25	25	60	80
ATN 12.7	20	—	80	—	TK10 K13	25	25	80	120
ATN 20	20	—	125	—	TK20 K13	18	25	120	180
ATL 5	25	25	40	60	ATK5 K6	25	25	60	80
ATL 10	25	25	80	150	ATK10 K6	25	25	60	120
ATL 20	25	25	160	250	ATK10 K13	20	25	60	120
ATP 10	15	25	50	120	ATK20 K13	20	25	120	180
ATP 15	20	30	100	160	ATN10 K6	25	—	80	—
MXL	10	18	15	15	ATN12.7 K6	20	—	80	—
XL	10	15	30	30	HK13	18	20	80	120
L	15	20	60	60	LK13	25	25	80	80

Take advantage of free engineering support.

PULLEYS FOR TIMING BELTS

ALUMINUM STOCK PULLEYS WITH PILOT BORE

T 5



For T 2.5 and TK5 K6 check stock

Belt Width = 10 mm					
# of teeth Z	Outside diameter d _k (mm)	Pitch diameter d _o (mm)	Face width B (mm)	Pilot bore d _v (mm)	Part Numbers
10	15.05	16.07	15	4	LS 21 T5-SE / 10-2 hub 8x6
12	18.25	19.25	15	4	LS 21 T5-SE / 12-2 hub 12x6
14	21.45	22.43	15	6	LS 21 T5-SE / 14-2 hub 14x6
15	23.05	24.02	15	6	LS 21 T5-SE / 15-2 hub 16x6
16	24.60	25.61	15	6	LS 21 T5-SE / 16-2 hub 18x6
18	27.80	28.80	15	6	LS 21 T5-SE / 18-2 hub 20x6
19	29.40	30.39	15	6	LS 21 T5-SE / 19-2 hub 22x6
20	31.00	31.98	15	6	LS 21 T5-SE / 20-2 hub 24x6
24	37.35	38.35	15	6	LS 21 T5 / 24-2 hub 26x6
25	38.95	39.94	15	6	LS 21 T5 / 25-2 hub 26x6
27	42.15	43.12	15	8	LS 21 T5 / 27-2 hub 30x6
30	46.90	47.90	15	8	LS 21 T5 / 30-2 hub 34x6
32	50.10	51.08	15	8	LS 21 T5 / 32-2 hub 38x6
36	56.45	57.45	15	8	LS 21 T5 / 36-2 hub 38x6
40	62.85	63.81	15	8	LS 21 T5 / 40-2 hub 40x6
48	75.55	76.54	15	8	LS 21 T5 / 48-0 hub 50x6
60	94.65	95.64	15	8	LS 21 T5 / 60-0 hub 65x6

Belt Width = 16 mm					
# of teeth Z	Outside diameter d _k (mm)	Pitch diameter d _o (mm)	Face width B (mm)	Pilot bore d _v (mm)	Part Numbers
10	15.05	16.07	21	4	LS 27 T5-SE / 10-2 hub 8x6
12	18.25	19.25	21	4	LS 27 T5-SE / 12-2 hub 12x6
14	21.45	22.43	21	6	LS 27 T5-SE / 14-2 hub 14x6
15	23.05	24.02	21	6	LS 27 T5-SE / 15-2 hub 16x6
16	24.60	25.61	21	6	LS 27 T5-SE / 16-2 hub 18x6
18	27.80	28.80	21	6	LS 27 T5-SE / 18-2 hub 20x6
19	29.40	30.39	21	6	LS 27 T5-SE / 19-2 hub 22x6
20	31.00	31.98	21	6	LS 27 T5-SE / 20-2 hub 24x6
24	37.35	38.35	21	6	LS 27 T5 / 24-2 hub 26x6
25	38.95	39.94	21	6	LS 27 T5 / 25-2 hub 26x6
27	42.15	43.12	21	8	LS 27 T5 / 27-2 hub 30x6
30	46.90	47.90	21	8	LS 27 T5 / 30-2 hub 34x6
32	50.10	51.08	21	8	LS 27 T5 / 32-2 hub 38x6
36	56.45	57.45	21	8	LS 27 T5 / 36-2 hub 38x6
40	62.85	63.81	21	8	LS 27 T5 / 40-2 hub 40x6
48	75.55	76.54	21	8	LS 27 T5 / 48-0 hub 50x6
60	94.65	95.64	21	8	LS 27 T5 / 60-0 hub 65x6

Belt Width = 25 mm					
# of teeth Z	Outside diameter d _k (mm)	Pitch diameter d _o (mm)	Face width B (mm)	Pilot bore d _v (mm)	Part Numbers
10	15.05	16.07	30	4	LS 36 T5-SE / 10-2 hub 8x6
12	18.25	19.25	30	4	LS 36 T5-SE / 12-2 hub 12x6
14	21.45	22.43	30	6	LS 36 T5-SE / 14-2 hub 14x6
15	23.05	24.02	30	6	LS 36 T5-SE / 15-2 hub 16x6
16	24.60	25.61	30	6	LS 36 T5-SE / 16-2 hub 18x6
18	27.80	28.80	30	6	LS 36 T5-SE / 18-2 hub 20x6
19	29.40	30.39	30	6	LS 36 T5-SE / 19-2 hub 22x6
20	31.00	31.98	30	6	LS 36 T5-SE / 20-2 hub 24x6
24	37.35	38.35	30	6	LS 36 T5 / 24-2 hub 26x6

Belt Width = 25 mm					
# of teeth Z	Outside diameter d _k (mm)	Pitch diameter d _o (mm)	Face width B (mm)	Pilot bore d _v (mm)	Part Numbers
25	38.95	39.94	30	6	LS 36 T5 / 25-2 hub 26x6
27	42.15	43.12	30	8	LS 36 T5 / 27-2 hub 30x6
30	46.90	47.90	30	8	LS 36 T5 / 30-2 hub 34x6
32	50.10	51.08	30	8	LS 36 T5 / 32-2 hub 38x6
36	56.45	57.45	30	8	LS 36 T5 / 36-2 hub 38x6
40	62.85	63.81	30	8	LS 36 T5 / 40-2 hub 40x6
48	75.55	76.54	30	8	LS 36 T5 / 48-0 hub 50x6
60	94.65	95.64	30	8	LS 36 T5 / 60-0 hub 65x6

Ordering example: BRECOflex Timing Belt Pulleys

LS 36 T5 - SE* / 18 - 2 Hub 20 x 6

Stock Pulley _____

Width over Hub _____

Pulley Pitch _____

Tooth Gap Design _____

No. of Teeth _____

No. of Flanges _____

Hub Diameter _____

Hub Width _____

*See Page 9

PULLEYS FOR TIMING BELTS

ALUMINUM STOCK PULLEYS WITH PILOT BORE

T 10



Belt Width = 16 mm					
# of teeth z	Outside diameter d _k (mm)	Pitch diameter d _o (mm)	Face width B (mm)	Pilot bore d _v (mm)	Part Numbers
12	36.35	38.35	21	6	LS 31 T10-SE / 12-2 hub 28x10
14	42.70	44.71	21	8	LS 31 T10-SE / 14-2 hub 32x10
15	45.90	47.90	21	8	LS 31 T10-SE / 15-2 hub 32x10
16	49.10	51.08	21	8	LS 31 T10-SE / 16-2 hub 35x10
18	55.45	57.45	21	10	LS 31 T10-SE / 18-2 hub 40x10
19	58.65	60.63	21	10	LS 31 T10-SE / 19-2 hub 44x10
20	61.80	63.81	21	12	LS 31 T10-SE / 20-2 hub 46x10
24	74.55	76.54	21	12	LS 31 T10 / 24-2 hub 58x10
25	77.75	79.73	21	12	LS 31 T10 / 25-2 hub 60x10
27	84.10	86.09	21	12	LS 31 T10 / 27-2 hub 60x10
30	93.65	95.64	21	12	LS 31 T10 / 30-2 hub 60x10
32	100.00	102.01	21	12	LS 31 T10 / 32-2 hub 65x10
36	112.75	114.74	21	16	LS 31 T10 / 36-2 hub 70x10
40	125.45	127.47	21	16	LS 31 T10 / 40-2 hub 80x10
48	150.95	152.94	21	16	LS 31 T10 / 48-0 hub 95x10
60	189.15	191.14	21	16	LS 31 T10 / 60-0 hub 110x10

Belt Width = 25 mm					
# of teeth z	Outside diameter d _k (mm)	Pitch diameter d _o (mm)	Face width B (mm)	Pilot bore d _v (mm)	Part Numbers
12	36.35	38.35	30	6	LS 40 T10-SE / 12-2 hub 28x10
14	42.70	44.71	30	8	LS 40 T10-SE / 14-2 hub 32x10
15	45.90	47.90	30	8	LS 40 T10-SE / 15-2 hub 32x10
16	49.10	51.08	30	8	LS 40 T10-SE / 16-2 hub 35x10
18	55.45	57.45	30	10	LS 40 T10-SE / 18-2 hub 40x10
19	58.65	60.63	30	10	LS 40 T10-SE / 19-2 hub 44x10
20	61.80	63.81	30	12	LS 40 T10-SE / 20-2 hub 46x10
24	74.55	76.54	30	12	LS 40 T10 / 24-2 hub 58x10
25	77.75	79.73	30	12	LS 40 T10 / 25-2 hub 60x10
27	84.10	86.09	30	12	LS 40 T10 / 27-2 hub 60x10
30	93.65	95.64	30	12	LS 40 T10 / 30-2 hub 60x10
32	100.00	102.01	30	12	LS 40 T10 / 32-2 hub 65x10
36	112.75	114.74	30	16	LS 40 T10 / 36-2 hub 70x10
40	125.45	127.47	30	16	LS 40 T10 / 40-2 hub 80x10
48	150.95	152.94	30	16	LS 40 T10 / 48-0 hub 95x10
60	189.15	191.14	30	16	LS 40 T10 / 60-0 hub 110x10

Belt Width = 32 mm					
# of teeth z	Outside diameter d _k (mm)	Pitch diameter d _o (mm)	Face width B (mm)	Pilot bore d _v (mm)	Part Numbers
18	55.45	57.45	40	10	LS 50 T10-SE / 18-2 hub 40x10
19	58.65	60.63	40	10	LS 50 T10-SE / 19-2 hub 44x10
20	61.80	63.81	40	12	LS 50 T10-SE / 20-2 hub 46x10
24	74.55	76.54	40	12	LS 50 T10 / 24-2 hub 58x10
25	77.75	79.73	40	12	LS 50 T10 / 25-2 hub 60x10
27	84.10	86.09	40	12	LS 50 T10 / 27-2 hub 60x10
30	93.65	95.64	40	12	LS 50 T10 / 30-2 hub 60x10
32	100.00	102.01	40	12	LS 50 T10 / 32-2 hub 65x10
36	112.75	114.74	40	16	LS 50 T10 / 36-2 hub 70x10
40	125.45	127.47	40	16	LS 50 T10 / 40-2 hub 80x10
48	150.95	152.94	40	16	LS 50 T10 / 48-0 hub 95x10
60	189.15	191.14	40	16	LS 50 T10 / 60-0 hub 110x10

Belt Width = 50 mm					
# of teeth z	Outside diameter d _k (mm)	Pitch diameter d _o (mm)	Face width B (mm)	Pilot bore d _v (mm)	Part Numbers
18	55.45	57.45	56	10	LS 66 T10-SE / 18-2 hub 40x10
19	58.65	60.63	56	10	LS 66 T10-SE / 19-2 hub 44x10
20	61.80	63.81	56	12	LS 66 T10-SE / 20-2 hub 46x10
24	74.55	76.54	56	12	LS 66 T10 / 24-2 hub 58x10
25	77.75	79.73	56	12	LS 66 T10 / 25-2 hub 60x10
27	84.10	86.09	56	12	LS 66 T10 / 27-2 hub 60x10
30	93.65	95.64	56	12	LS 66 T10 / 30-2 hub 60x10
32	100.00	102.01	56	12	LS 66 T10 / 32-2 hub 65x10
36	112.75	114.74	56	16	LS 66 T10 / 36-2 hub 70x10
40	125.45	127.47	56	16	LS 66 T10 / 40-2 hub 80x10
48	150.95	152.94	56	16	LS 66 T10 / 48-0 hub 95x10
60	189.15	191.14	56	16	LS 66 T10 / 60-0 hub 110x10

PULLEYS FOR TIMING BELTS

ALUMINUM STOCK PULLEYS WITH PILOT BORE

AT 5



Belt Width = 16 mm						
# of teeth z	Outside diameter d _k (mm)	Pitch diameter d _o (mm)	Root diameter d _r (mm)	Face width B (mm)	Pilot bore d _v (mm)	Part Numbers
12	17.88	19.28	15.68	22	4	LS 28 AT5 / 12-2 hub 12x6
14	21.06	22.46	18.86	22	6	LS 28 AT5 / 14-2 hub 14x6
15	22.65	24.05	20.45	22	6	LS 28 AT5 / 15-2 hub 16x6
16	24.24	25.64	22.04	22	6	LS 28 AT5 / 16-2 hub 18x6
18	27.43	28.83	25.23	22	6	LS 28 AT5 / 18-2 hub 20x6
19	29.02	30.42	26.82	22	6	LS 28 AT5 / 19-2 hub 22x6
20	30.61	32.01	28.41	22	6	LS 28 AT5 / 20-2 hub 24x6
22	33.79	35.19	31.59	22	6	LS 28 AT5 / 22-2 hub 24x6
24	36.98	38.38	34.78	22	8	LS 28 AT5 / 24-2 hub 26x6
25	38.57	39.97	36.37	22	8	LS 28 AT5 / 25-2 hub 26x6
27	41.75	43.15	39.55	22	8	LS 28 AT5 / 27-2 hub 30x6
30	46.53	47.93	44.33	22	8	LS 28 AT5 / 30-2 hub 34x6
32	49.71	51.11	47.51	22	8	LS 28 AT5 / 32-2 hub 38x6
36	56.08	57.48	53.88	22	8	LS 28 AT5 / 36-2 hub 38x6
40	62.44	63.84	60.24	22	8	LS 28 AT5 / 40-2 hub 40x6
44	68.81	70.21	66.61	22	8	LS 28 AT5 / 44-2 hub 50x6
48	75.17	76.57	72.97	22	8	LS 28 AT5 / 48-0 hub 50x6
60	94.27	95.67	92.07	22	8	LS 28 AT5 / 60-0 hub 65x6
72	113.37	114.77	111.17	22	8	LS 28 AT5 / 72-0 hub 80x6

Belt Width = 25 mm						
# of teeth z	Outside diameter d _k (mm)	Pitch diameter d _o (mm)	Root diameter d _r (mm)	Face width B (mm)	Pilot bore d _v (mm)	Part Numbers
12	17.88	19.28	15.68	32	4	LS 38 AT5 / 12-2 hub 12x6
14	21.06	22.46	18.86	32	6	LS 38 AT5 / 14-2 hub 14x6
15	22.65	24.05	20.45	32	6	LS 38 AT5 / 15-2 hub 16x6
16	24.24	25.64	22.04	32	6	LS 38 AT5 / 16-2 hub 18x6
18	27.43	28.83	25.23	32	6	LS 38 AT5 / 18-2 hub 20x6
19	29.02	30.42	26.82	32	6	LS 38 AT5 / 19-2 hub 22x6
20	30.61	32.01	28.41	32	6	LS 38 AT5 / 20-2 hub 24x6
22	33.79	35.19	31.59	32	6	LS 38 AT5 / 22-2 hub 24x6
24	36.98	38.38	34.78	32	8	LS 38 AT5 / 24-2 hub 26x6
25	38.57	39.97	36.37	32	8	LS 38 AT5 / 25-2 hub 26x6
27	41.75	43.15	39.55	32	8	LS 38 AT5 / 27-2 hub 30x6
30	46.53	47.93	44.33	32	8	LS 38 AT5 / 30-2 hub 34x6
32	49.71	51.11	47.51	32	8	LS 38 AT5 / 32-2 hub 38x6
36	56.08	57.48	53.88	32	8	LS 38 AT5 / 36-2 hub 38x6
40	62.44	63.84	60.24	32	8	LS 38 AT5 / 40-2 hub 40x6
44	68.81	70.21	66.61	32	8	LS 38 AT5 / 44-2 hub 50x6
48	75.17	76.57	72.97	32	8	LS 38 AT5 / 48-0 hub 50x6
60	94.27	95.67	92.07	32	8	LS 38 AT5 / 60-0 hub 65x6
72	113.37	114.77	111.17	32	8	LS 38 AT5 / 72-0 hub 80x6

Belt Width = 32 mm						
# of teeth z	Outside diameter d _k (mm)	Pitch diameter d _o (mm)	Root diameter d _r (mm)	Face width B (mm)	Pilot bore d _v (mm)	Part Numbers
12	17.88	19.28	15.68	40	4	LS 46 AT5 / 12-2 hub 12x6
14	21.06	22.46	18.86	40	6	LS 46 AT5 / 14-2 hub 14x6
15	22.65	24.05	20.45	40	6	LS 46 AT5 / 15-2 hub 16x6
16	24.24	25.64	22.04	40	6	LS 46 AT5 / 16-2 hub 18x6
18	27.43	28.83	25.23	40	6	LS 46 AT5 / 18-2 hub 20x6
19	29.02	30.42	26.82	40	6	LS 46 AT5 / 19-2 hub 22x6
20	30.61	32.01	28.41	40	6	LS 46 AT5 / 20-2 hub 24x6
22	33.79	35.19	31.59	40	6	LS 46 AT5 / 22-2 hub 24x6
24	36.98	38.38	34.78	40	8	LS 46 AT5 / 24-2 hub 26x6
25	38.57	39.97	36.37	40	8	LS 46 AT5 / 25-2 hub 26x6

Belt Width = 32 mm						
# of teeth z	Outside diameter d _k (mm)	Pitch diameter d _o (mm)	Root diameter d _r (mm)	Face width B (mm)	Pilot bore d _v (mm)	Part Numbers
27	41.75	43.15	39.55	40	8	LS 46 AT5 / 27-2 hub 30x6
30	46.53	47.93	44.33	40	8	LS 46 AT5 / 30-2 hub 34x6
32	49.71	51.11	47.51	40	8	LS 46 AT5 / 32-2 hub 38x6
36	56.08	57.48	53.88	40	8	LS 46 AT5 / 36-2 hub 38x6
40	62.44	63.84	60.24	40	8	LS 46 AT5 / 40-2 hub 40x6
44	68.81	70.21	66.61	40	8	LS 46 AT5 / 44-2 hub 50x6
48	75.17	76.57	72.97	40	8	LS 46 AT5 / 48-0 hub 50x6
60	94.27	95.67	92.07	40	8	LS 46 AT5 / 60-0 hub 65x6
72	113.37	114.77	111.17	40	8	LS 46 AT5 / 72-0 hub 80x6

PULLEYS FOR TIMING BELTS

ALUMINUM STOCK PULLEYS WITH PILOT BORE

AT 10 —



Belt Width = 25 mm						
# of teeth z	Outside diameter d _k (mm)	Pitch diameter d _o (mm)	Root diameter d _r (mm)	Face width B (mm)	Pilot bore d _v (mm)	Part Numbers
12	36.38	38.38	31.68	32	6	LS 42 AT10 / 12-2 hub 28x10
14	42.74	44.74	38.04	32	8	LS 42 AT10 / 14-2 hub 32x10
15	45.93	47.93	41.23	32	8	LS 42 AT10 / 15-2 hub 32x10
16	49.11	51.11	44.41	32	8	LS 42 AT10 / 16-2 hub 35x10
18	55.48	57.48	50.78	32	8	LS 42 AT10 / 18-2 hub 40x10
19	58.66	60.66	53.96	32	8	LS 42 AT10 / 19-2 hub 44x10
20	61.84	63.84	57.14	32	12	LS 42 AT10 / 20-2 hub 46x10
22	68.21	70.21	63.51	32	12	LS 42 AT10 / 22-2 hub 50x10
24	74.57	76.57	69.87	32	12	LS 42 AT10 / 24-2 hub 58x10
25	77.76	79.76	73.06	32	12	LS 42 AT10 / 25-2 hub 60x10
27	84.12	86.12	79.42	32	12	LS 42 AT10 / 27-2 hub 60x10
30	93.67	95.67	88.97	32	12	LS 42 AT10 / 30-2 hub 60x10
32	100.04	102.04	95.34	32	12	LS 42 AT10 / 32-2 hub 65x10
36	112.77	114.77	108.07	32	16	LS 42 AT10 / 36-2 hub 70x10
40	125.50	127.50	120.80	32	16	LS 42 AT10 / 40-2 hub 80x10
44	138.24	140.24	133.54	32	16	LS 42 AT10 / 44-2 hub 90x10
48	150.97	152.97	146.27	32	16	LS 42 AT10 / 48-0 hub 95x10
60	189.17	191.17	184.47	32	16	LS 42 AT10 / 60-0 hub 110x10

Belt Width = 32 mm						
# of teeth z	Outside diameter d _k (mm)	Pitch diameter d _o (mm)	Root diameter d _r (mm)	Face width B (mm)	Pilot bore d _v (mm)	Part Numbers
18	55.48	57.48	50.78	40	8	LS 50 AT10 / 18-2 hub 40x10
19	58.66	60.66	53.96	40	8	LS 50 AT10 / 19-2 hub 44x10
20	61.84	63.84	57.14	40	12	LS 50 AT10 / 20-2 hub 46x10
22	68.21	70.21	63.51	40	12	LS 50 AT10 / 22-2 hub 50x10
24	74.57	76.57	69.87	40	12	LS 50 AT10 / 24-2 hub 58x10
25	77.76	79.76	73.06	40	12	LS 50 AT10 / 25-2 hub 60x10
27	84.12	86.12	79.42	40	12	LS 50 AT10 / 27-2 hub 60x10
30	93.67	95.67	88.97	40	12	LS 50 AT10 / 30-2 hub 60x10
32	100.04	102.04	95.34	40	12	LS 50 AT10 / 32-2 hub 65x10
36	112.77	114.77	108.07	40	16	LS 50 AT10 / 36-2 hub 70x10
40	125.50	127.50	120.80	40	16	LS 50 AT10 / 40-2 hub 80x10
44	138.24	140.24	133.54	40	16	LS 50 AT10 / 44-2 hub 90x10
48	150.97	152.97	146.27	40	16	LS 50 AT10 / 48-0 hub 95x10
60	189.17	191.17	184.47	40	16	LS 50 AT10 / 60-0 hub 110x10

Belt Width = 50 mm						
# of teeth z	Outside diameter d _k (mm)	Pitch diameter d _o (mm)	Root diameter d _r (mm)	Face width B (mm)	Pilot bore d _v (mm)	Part Numbers
18	55.48	57.48	50.78	60	8	LS 70 AT10 / 18-2 hub 40x10
19	58.66	60.66	53.96	60	8	LS 70 AT10 / 19-2 hub 44x10
20	61.84	63.84	57.14	60	12	LS 70 AT10 / 20-2 hub 46x10
22	68.21	70.21	63.51	60	12	LS 70 AT10 / 22-2 hub 50x10
24	74.57	76.57	69.87	60	12	LS 70 AT10 / 24-2 hub 58x10
25	77.76	79.76	73.06	60	12	LS 70 AT10 / 25-2 hub 60x10
27	84.12	86.12	79.42	60	12	LS 70 AT10 / 27-2 hub 60x10

Belt Width = 50 mm						
# of teeth z	Outside diameter d _k (mm)	Pitch diameter d _o (mm)	Root diameter d _r (mm)	Face width B (mm)	Pilot bore d _v (mm)	Part Numbers
30	93.67	95.67	88.97	60	12	LS 70 AT10 / 30-2 hub 60x10
32	100.04	102.04	95.34	60	12	LS 70 AT10 / 32-2 hub 65x10
36	112.77	114.77	108.07	60	16	LS 70 AT10 / 36-2 hub 70x10
40	125.50	127.50	120.80	60	16	LS 70 AT10 / 40-2 hub 80x10
44	138.24	140.24	133.54	60	16	LS 70 AT10 / 44-2 hub 90x10
48	150.97	152.97	146.27	60	16	LS 70 AT10 / 48-0 hub 95x10
60	189.17	191.17	184.47	60	16	LS 70 AT10 / 60-0 hub 110x10

Ordering example: BRECOflex Timing Belt Pulleys

LS 70 AT10 / 24 - 2 Hub 58 x 10

Stock Pulley _____

Width over Hub _____

Pulley Pitch _____

No. of Teeth _____

No. of Flanges _____

Hub Diameter _____

Hub Width _____

PULLEYS FOR TIMING BELTS

ALUMINUM STOCK PULLEYS WITH PILOT BORE

XL = T1/5" —



Belt Width = 12.7 mm

# of teeth z	Outside diameter d _k (mm)	Pitch diameter d _o (mm)	Face width B (mm)	Pilot bore d _v (mm)	Part Numbers
10	15.66	16.17	19	4	LS 25 T1/5" / 10-2 hub 10x6
11	17.28	17.79	19	4	LS 25 T1/5" / 11-2 hub 10x6
12	18.90	19.40	19	4	LS 25 T1/5" / 12-2 hub 13x6
14	22.13	22.64	19	6	LS 25 T1/5" / 14-2 hub 14x6
15	23.75	24.25	19	6	LS 25 T1/5" / 15-2 hub 16x6
16	25.36	25.87	19	6	LS 25 T1/5" / 16-2 hub 18x6
18	28.60	29.10	19	6	LS 25 T1/5" / 18-2 hub 21x6
20	31.83	32.34	19	6	LS 27 T1/5" / 20-2 hub 24x8
21	33.45	33.96	19	6	LS 27 T1/5" / 21-2 hub 24x8
22	35.07	35.57	19	6	LS 27 T1/5" / 22-2 hub 25x8
24	38.30	38.81	19	6	LS 27 T1/5" / 24-2 hub 27x8
28	44.77	45.27	19	6	LS 27 T1/5" / 28-2 hub 30x8
30	48.00	48.51	19	6	LS 27 T1/5" / 30-2 hub 35x8
32	51.24	51.74	19	8	LS 30 T1/5" / 32-2 hub 38x11
36	57.70	58.21	19	8	LS 30 T1/5" / 36-2 hub 38x11
40	64.17	64.68	19	8	LS 30 T1/5" / 40-2 hub 38x11

Belt Width = 25.4 mm

# of teeth z	Outside diameter d _k (mm)	Pitch diameter d _o (mm)	Face width B (mm)	Pilot bore d _v (mm)	Part Numbers
10	15.66	16.17	32	4	LS 38 T1/5" / 10-2 hub 10x6
11	17.28	17.79	32	4	LS 38 T1/5" / 11-2 hub 10x6
12	18.90	19.40	32	4	LS 38 T1/5" / 12-2 hub 13x6
14	22.13	22.64	32	6	LS 38 T1/5" / 14-2 hub 14x6
15	23.75	24.25	32	6	LS 38 T1/5" / 15-2 hub 16x6
16	25.36	25.87	32	6	LS 38 T1/5" / 16-2 hub 18x6
18	28.60	29.10	32	6	LS 38 T1/5" / 18-2 hub 21x6
20	31.83	32.34	32	6	LS 40 T1/5" / 20-2 hub 24x8
21	33.45	33.96	32	6	LS 40 T1/5" / 21-2 hub 24x8
22	35.07	35.57	32	6	LS 40 T1/5" / 22-2 hub 25x8
24	38.30	38.81	32	6	LS 40 T1/5" / 24-2 hub 27x8
28	44.77	45.27	32	6	LS 40 T1/5" / 28-2 hub 30x8
30	48.00	48.51	32	6	LS 40 T1/5" / 30-2 hub 35x8
32	51.24	51.74	32	8	LS 43 T1/5" / 32-2 hub 38x11
36	57.70	58.21	32	8	LS 43 T1/5" / 36-2 hub 38x11
40	64.17	64.68	32	8	LS 43 T1/5" / 40-2 hub 38x11

PULLEYS FOR TIMING BELTS

ALUMINUM STOCK PULLEYS WITH PILOT BORE

L = T3/8" —



Belt Width = 25.4 mm					
# of teeth z	Outside diameter d _k (mm)	Pitch diameter d _o (mm)	Face width B (mm)	Pilot bore d _v (mm)	Part Numbers
10	29.57	30.33	32	8	LS 40 T3/8" / 10-2 hub 22x8
11	32.60	33.36	32	8	LS 40 T3/8" / 11-2 hub 24x8
12	35.63	36.40	32	8	LS 40 T3/8" / 12-2 hub 28x8
13	38.66	39.43	32	8	LS 40 T3/8" / 13-2 hub 30x8
14	41.70	42.46	32	8	LS 40 T3/8" / 14-2 hub 33x8
15	44.72	45.49	32	8	LS 40 T3/8" / 15-2 hub 36x8
16	47.75	48.52	32	8	LS 40 T3/8" / 16-2 hub 38x8
17	50.78	51.55	32	10	LS 40 T3/8" / 17-2 hub 40x8
18	53.81	54.59	32	10	LS 40 T3/8" / 18-2 hub 40x8
19	56.84	57.62	32	10	LS 40 T3/8" / 19-2 hub 40x8
20	59.88	60.65	32	10	LS 42 T3/8" / 20-2 hub 46x10
21	62.91	63.68	32	10	LS 42 T3/8" / 21-2 hub 46x10
22	65.94	66.71	32	10	LS 42 T3/8" / 22-2 hub 50x10
24	72.00	72.78	32	12	LS 42 T3/8" / 24-2 hub 50x10

Belt Width = 50.8 mm					
# of teeth z	Outside diameter d _k (mm)	Pitch diameter d _o (mm)	Face width B (mm)	Pilot bore d _v (mm)	Part Numbers
10	29.57	30.33	59	8	LS 69 T3/8" / 10-2 hub 22x10
11	32.60	33.36	59	8	LS 69 T3/8" / 11-2 hub 24x10
12	35.63	36.40	59	8	LS 69 T3/8" / 12-2 hub 28x10
13	38.66	39.43	59	8	LS 69 T3/8" / 13-2 hub 30x10
14	41.70	42.46	59	8	LS 69 T3/8" / 14-2 hub 33x10
15	44.72	45.49	59	8	LS 69 T3/8" / 15-2 hub 36x10
16	47.75	48.52	59	8	LS 69 T3/8" / 16-2 hub 38x10
17	50.78	51.55	59	10	LS 69 T3/8" / 17-2 hub 40x10
18	53.81	54.59	59	10	LS 69 T3/8" / 18-2 hub 40x10
19	56.84	57.62	59	10	LS 69 T3/8" / 19-2 hub 40x10
20	59.88	60.65	59	10	LS 69 T3/8" / 20-2 hub 46x10
21	62.91	63.68	59	10	LS 69 T3/8" / 21-2 hub 46x10
22	65.94	66.71	59	10	LS 69 T3/8" / 22-2 hub 50x10
24	72.00	72.78	59	12	LS 69 T3/8" / 24-2 hub 50x10

Ordering example: BRECOflex Timing Belt Pulleys LS 69 T3/8" / 18 - 2 Hub 40 x 10

Stock Pulley	_____	_____	_____	_____	_____
Width over Hub	_____	_____	_____	_____	_____
Pulley Pitch	_____	_____	_____	_____	_____
No. of Teeth	_____	_____	_____	_____	_____
No. of Flanges	_____	_____	_____	_____	_____
Hub Diameter	_____	_____	_____	_____	_____
Hub Width	_____	_____	_____	_____	_____

PULLEYS FOR TIMING BELTS

ALUMINUM STOCK PULLEYS WITH PILOT BORE

H = T1/2" —

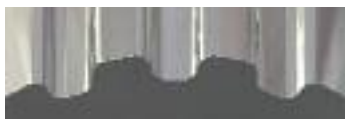

Belt Width = 25.4 mm					
# of teeth z	Outside diameter d _k (mm)	Pitch diameter d _o (mm)	Face width B (mm)	Pilot bore d _v (mm)	Part Numbers
14	55.23	56.60	32	12	LS 42 T1/2" / 14-2 hub 40x10
16	63.31	64.68	32	15	LS 42 T1/2" / 16-2 hub 46x10
18	71.39	72.77	32	15	LS 42 T1/2" / 18-2 hub 54x10
20	79.48	80.85	32	15	LS 42 T1/2" / 20-2 hub 62x10
22	87.56	88.94	32	15	LS 42 T1/2" / 22-2 hub 70x10
24	95.65	97.02	32	15	LS 42 T1/2" / 24-2 hub 75x10
26	103.73	105.11	32	15	LS 42 T1/2" / 26-2 hub 75x10
28	111.82	113.19	32	15	LS 42 T1/2" / 28-2 hub 75x10
30	119.90	121.28	32	15	LS 42 T1/2" / 30-2 hub 80x10
32	127.99	129.36	32	20	LS 42 T1/2" / 32-2 hub 85x10
36	144.16	145.53	32	20	LS 42 T1/2" / 36-2 hub 90x10
40	160.33	161.70	32	20	LS 42 T1/2" / 40-2 hub 95x10

Belt Width = 38.1 mm					
# of teeth z	Outside diameter d _k (mm)	Pitch diameter d _o (mm)	Face width B (mm)	Pilot bore d _v (mm)	Part Numbers
14	55.23	56.60	44	12	LS 54 T1/2" / 14-2 hub 40x10
16	63.31	64.68	44	15	LS 54 T1/2" / 16-2 hub 46x10
18	71.39	72.77	44	15	LS 54 T1/2" / 18-2 hub 54x10
20	79.48	80.85	44	15	LS 54 T1/2" / 20-2 hub 62x10
22	87.56	88.94	44	15	LS 54 T1/2" / 22-2 hub 70x10
24	95.65	97.02	44	15	LS 54 T1/2" / 24-2 hub 75x10
26	103.73	105.11	44	15	LS 54 T1/2" / 26-2 hub 75x10
28	111.82	113.19	44	15	LS 54 T1/2" / 28-2 hub 75x10
30	119.90	121.28	44	15	LS 54 T1/2" / 30-2 hub 80x10
32	127.99	129.36	44	20	LS 54 T1/2" / 32-2 hub 85x10
36	144.16	145.53	44	20	LS 54 T1/2" / 36-2 hub 90x10
40	160.33	161.70	44	20	LS 54 T1/2" / 40-2 hub 95x10

Belt Width = 50.8 mm					
# of teeth z	Outside diameter d _k (mm)	Pitch diameter d _o (mm)	Face width B (mm)	Pilot bore d _v (mm)	Part Numbers
14	55.23	56.60	59	12	LS 69 T1/2" / 14-2 hub 40x10
16	63.31	64.68	59	15	LS 69 T1/2" / 16-2 hub 46x10
18	71.39	72.77	59	15	LS 69 T1/2" / 18-2 hub 54x10
20	79.48	80.85	59	15	LS 69 T1/2" / 20-2 hub 62x10
22	87.56	88.94	59	15	LS 69 T1/2" / 22-2 hub 70x10
24	95.65	97.02	59	15	LS 69 T1/2" / 24-2 hub 75x10
26	103.73	105.11	59	15	LS 69 T1/2" / 26-2 hub 75x10
28	111.82	113.19	59	15	LS 69 T1/2" / 28-2 hub 75x10
30	119.90	121.28	59	15	LS 69 T1/2" / 30-2 hub 80x10
32	127.99	129.36	59	20	LS 69 T1/2" / 32-2 hub 85x10
36	144.16	145.53	59	20	LS 69 T1/2" / 36-2 hub 90x10
40	160.33	161.70	59	20	LS 69 T1/2" / 40-2 hub 95x10

Belt Width = 76.2 mm					
# of teeth z	Outside diameter d _k (mm)	Pitch diameter d _o (mm)	Face width B (mm)	Pilot bore d _v (mm)	Part Numbers
14	55.23	56.60	84	12	LS 96 T1/2" / 14-2 hub 40x12
16	63.31	64.68	84	15	LS 96 T1/2" / 16-2 hub 46x12
18	71.39	72.77	84	15	LS 96 T1/2" / 18-2 hub 54x12
20	79.48	80.85	84	15	LS 96 T1/2" / 20-2 hub 62x12
22	87.56	88.94	84	15	LS 96 T1/2" / 22-2 hub 70x12
24	95.65	97.02	84	15	LS 96 T1/2" / 24-2 hub 75x12
26	103.73	105.11	84	15	LS 96 T1/2" / 26-2 hub 75x12
28	111.82	113.19	84	15	LS 96 T1/2" / 28-2 hub 75x12
30	119.90	121.28	84	15	LS 96 T1/2" / 30-2 hub 80x12
32	127.99	129.36	84	20	LS 96 T1/2" / 32-2 hub 85x12
36	144.16	145.53	84	20	LS 96 T1/2" / 36-2 hub 90x12
40	160.33	161.70	84	20	LS 96 T1/2" / 40-2 hub 95x12

PULLEYS FOR TIMING BELTS

ALUMINUM STOCK PULLEYS WITH PILOT BORE

TK10 K13



Self-tracking groove – see page 20

Belt Width = 50 mm

# of teeth z	Outside diameter d _k (mm)	Pitch diameter d _o (mm)	Face width B (mm)	Pilot bore d _v (mm)	Part Numbers
20	61.80	63.81	55	12	AL 55 TK10 K13-SE / 20-0
24	74.55	76.54	55	12	AL 55 TK10 K13 / 24-0
25	77.75	79.73	55	12	AL 55 TK10 K13 / 25-0
27	84.10	86.09	55	12	AL 55 TK10 K13 / 27-0
30	93.65	95.64	55	12	AL 55 TK10 K13 / 30-0
32	100.00	102.01	55	12	AL 55 TK10 K13 / 32-0
36	112.75	114.74	55	16	AL 55 TK10 K13 / 36-0
40	125.45	127.47	55	16	AL 55 TK10 K13 / 40-0
48	150.95	152.94	55	16	AL 55 TK10 K13 / 48-0
60	189.15	191.14	55	16	AL 55 TK10 K13 / 60-0

Belt Width = 100 mm

# of teeth z	Outside diameter d _k (mm)	Pitch diameter d _o (mm)	Face width B (mm)	Pilot bore d _v (mm)	Part Numbers
20	61.80	63.81	105	12	AL 105 TK10 K13-SE / 20-0
24	74.55	76.54	105	12	AL 105 TK10 K13 / 24-0
25	77.75	79.73	105	12	AL 105 TK10 K13 / 25-0
27	84.10	86.09	105	12	AL 105 TK10 K13 / 27-0
30	93.65	95.64	105	12	AL 105 TK10 K13 / 30-0
32	100.00	102.01	105	12	AL 105 TK10 K13 / 32-0
36	112.75	114.74	105	16	AL 105 TK10 K13 / 36-0
40	125.45	127.47	105	16	AL 105 TK10 K13 / 40-0
48	150.95	152.94	105	16	AL 105 TK10 K13 / 48-0
60	189.15	191.14	105	16	AL 105 TK10 K13 / 60-0

Ordering example: BRECOflex Timing Belt Pulleys

LS 55 TK10 K13 / 32 - 0

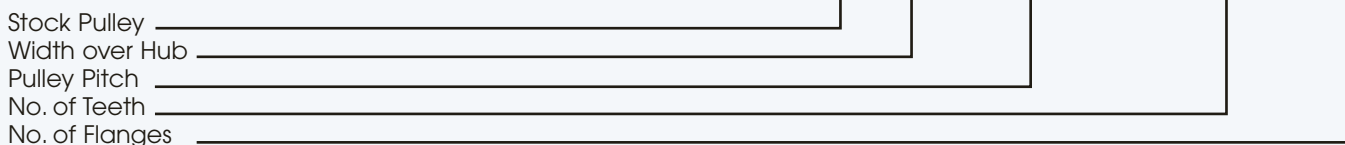

PULLEYS FOR TIMING BELTS

ALUMINUM STOCK PULLEYS WITH PILOT BORE

HK 13



Self-tracking groove – see drawings below

Belt Width = 50.8 mm					
# of teeth Z	Outside diameter d _k (mm)	Pitch diameter d _o (mm)	Face width B (mm)	Pilot bore d _v (mm)	Part Numbers
20	79.48	80.85	55	12	AL 55 HK13 / 20-0
24	95.65	97.02	55	12	AL 55 HK13 / 24-0
25	99.69	101.07	55	15	AL 55 HK13 / 25-0
27	107.78	109.15	55	15	AL 55 HK13 / 27-0
30	119.90	121.28	55	15	AL 55 HK13 / 30-0
32	127.99	129.36	55	20	AL 55 HK13 / 32-0
36	144.16	145.53	55	20	AL 55 HK13 / 36-0
40	160.33	161.70	55	20	AL 55 HK13 / 40-0
48	192.67	194.04	55	20	AL 55 HK13 / 48-0
60	241.18	242.55	55	20	AL 55 HK13 / 60-0

Belt Width = 101.6 mm					
# of teeth Z	Outside diameter d _k (mm)	Pitch diameter d _o (mm)	Face width B (mm)	Pilot bore d _v (mm)	Part Numbers
20	79.48	80.85	105	12	AL 105 HK13 / 20-0
24	95.65	97.02	105	12	AL 105 HK13 / 24-0
25	99.69	101.07	105	15	AL 105 HK13 / 25-0
27	107.78	109.15	105	15	AL 105 HK13 / 27-0
30	119.90	121.28	105	15	AL 105 HK13 / 30-0
32	127.99	129.36	105	20	AL 105 HK13 / 32-0
36	144.16	145.53	105	20	AL 105 HK13 / 36-0
40	160.33	161.70	105	20	AL 105 HK13 / 40-0
48	192.67	194.04	105	20	AL 105 HK13 / 48-0
60	241.18	242.55	105	20	AL 105 HK13 / 60-0

AVAILABLE SELF-TRACKING GROOVES

**TYPE K6
(METRIC AND IMPERIAL)**

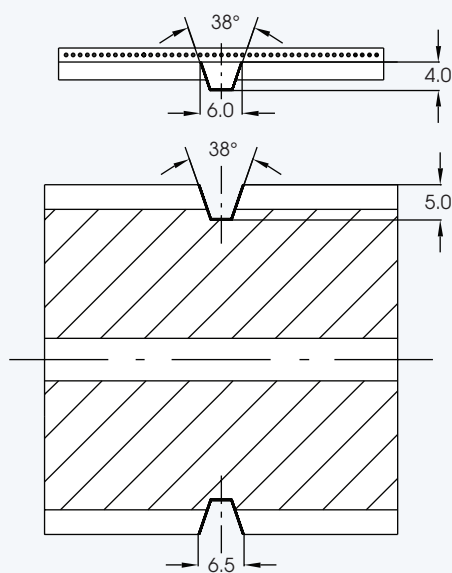

**TYPE K13
(METRIC AND IMPERIAL)**

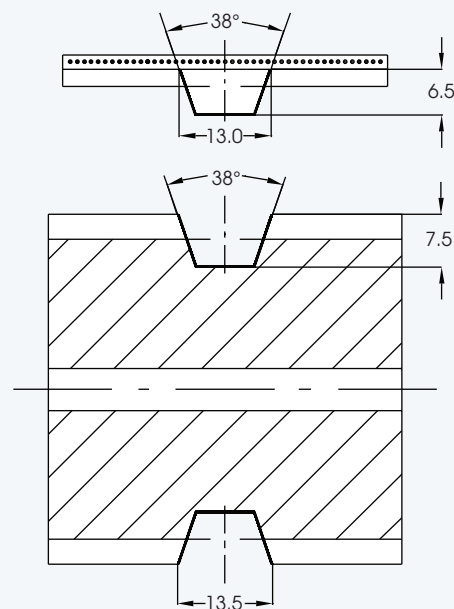

PULLEYS FOR TIMING BELTS

ACCESSORIES

(see Catalog B205)

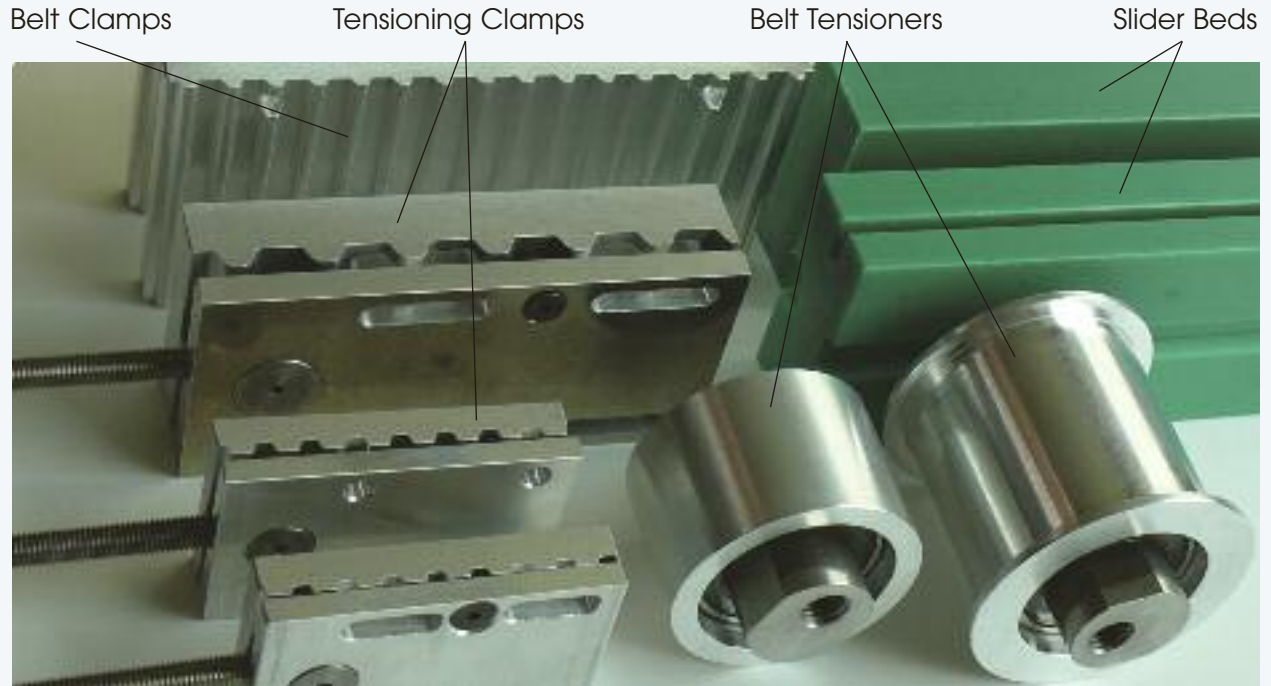

BAR STOCK WITH BLIND HOLES

Available in all tooth pitches

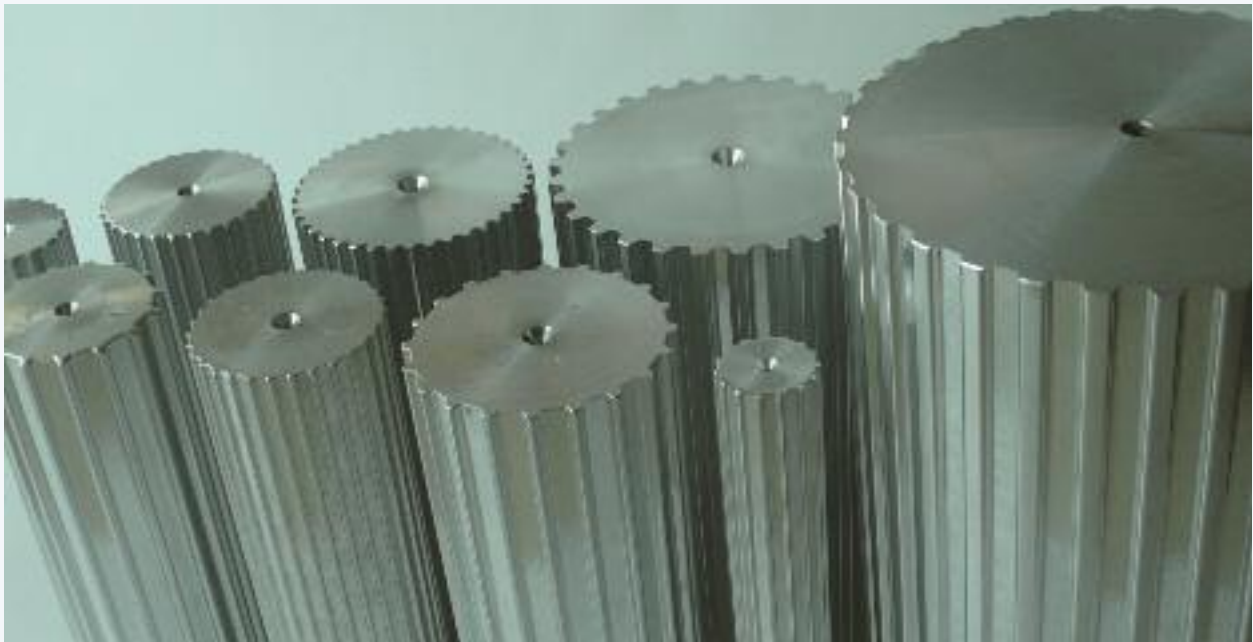

PULLEYS FOR TIMING BELTS

BELT/PULLEY CALCULATION

Calculation Program

The Belt/Pulley Calculation program is leading you step by step through the calculation process. Please visit our webpage at www.brecoflex.com to access the Calculation Program.

Power Transmission Applications

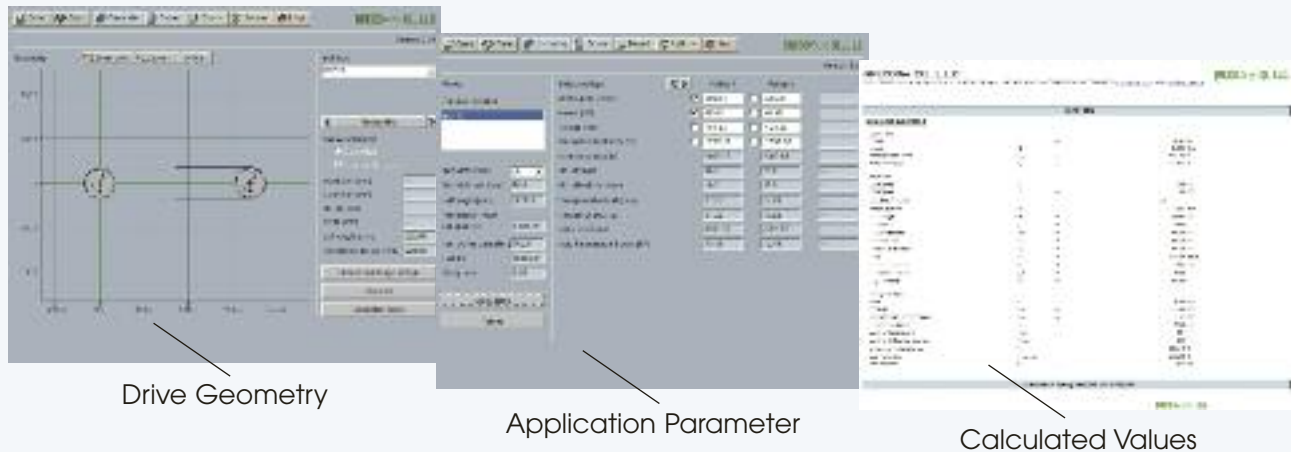

Linear Drive Applications

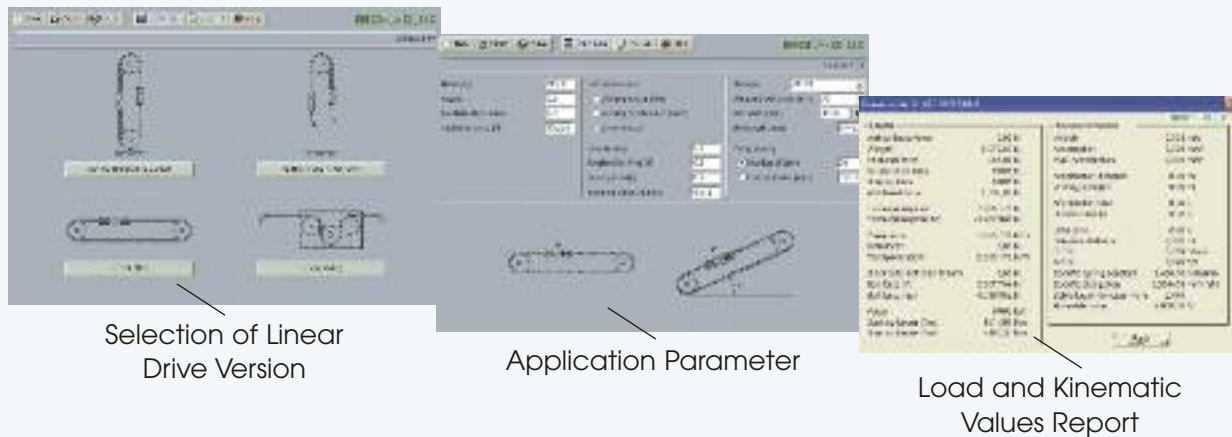

DRAWINGS IN "2D" & "3D"

Download "2D" or "3D" drawings from our webpage www.brecoflex.com accessible with:

PRO/E Part/Assembly – Solidworks Part/Assembly 2005/2006 – Solidworks Part/Assembly 2004 – CATIA V5 – CATIA V4 – ANVIL – CADKey 3D – AUTOCAD 3D – IGES – STEP – Inventor – IronCAD – Mechanical Desktop – ACIS – SDRC I-DEAS – Unigraphics – AUTOCAD 2D – DXF Files – Solidworks edrawings

BRECOflex PRODUCT CATALOGS



Polyurethane Timing Belts

Main Catalog (184 pages)
Metric and English Pitches.

See BRECOflex catalog # B212

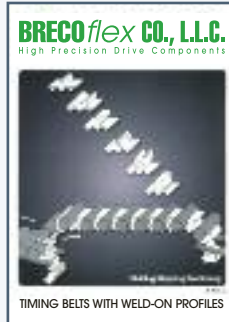

Polyurethane Timing Belts with Weld-on Profiles

Dividing, Stepping, Positioning.

See BRECOflex catalog # B203

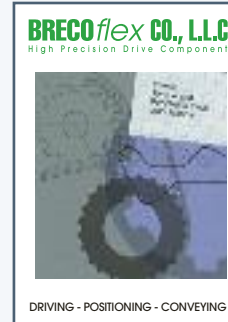

Calculations Driving, Positioning, Conveying

Power, Torque, and Peripheral Force calculations.

See BRECOflex catalog # B204

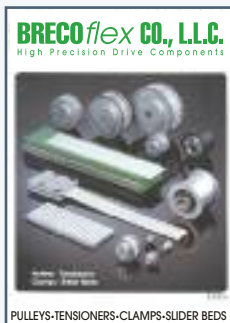

Accessory Items for Polyurethane Timing Belts

Pulleys, Tensioners, Clamps, Slider Beds.

See BRECOflex catalog # B205

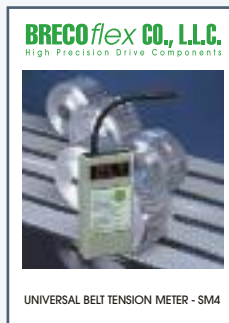

Tension Meter

Improve performance, lifetime, positioning accuracy, bearing load, and noise level.

See BRECOflex catalog # B207

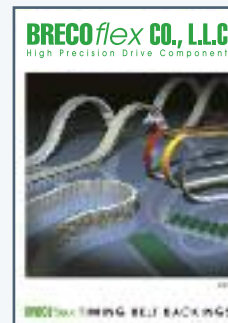

Timing Belt Backings

Polyurethane Timing Belts in Metric and English pitches with a wide range of cover materials.

See BRECOflex catalog # B208

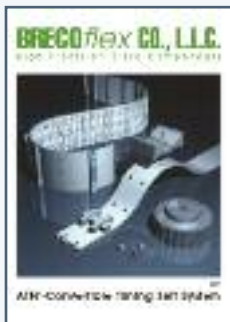

ATN® - Convertible Timing Belt System

ATN technology allows the reconfiguration of profiled timing belts at the customer site.

See BRECOflex catalog # B209



ESBAND Truly Endless Woven Flat Belts

Wide variety of Polyurethane, Neoprene and Silicone state-of-the-art flat belts.

See BRECOflex catalog # B210

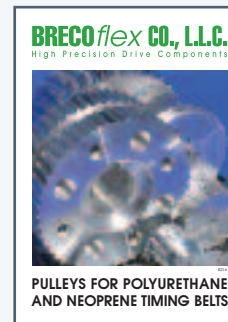

Pulleys for Polyurethane and Neoprene Timing Belts

Finished pulleys and stock pulley program.

See BRECOflex catalog # B216

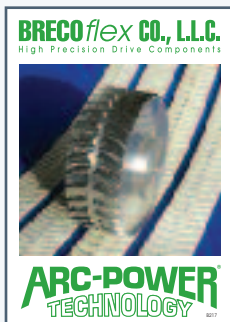

ARC-POWER Technology

Circular "ARC" tooth shape.

See BRECOflex catalog # B217

All recommendations for the use of the products described herein and all other data or information set forth in this publication, whether concerning such products or otherwise, are furnished without any guarantee, warranty representations or inducement of any kind whether expressed or implied, including but not limited to warranties of merchantability and fitness for a particular purpose. BRECOflex CO., L.L.C. expressly disclaims liability under any theory, including without limitation, contract negligence, misrepresentation or breach of any obligation relating to the recommendation, data or information set forth herein. Readers and customers are encouraged to conduct their own test before using any product. Read its label and all related instructions.

BRECOflex CO., L.L.C. reserves the right to make changes in the technical and dimensional specifications of its products without prior notice. Responsibility for expenses incurred as a result of product changes or discontinuance of a product lies solely with the purchaser.

BRECO *flex* CO., L.L.C.

High Precision Drive Components



Printed in USA 07/08

BRECO *flex* CO., L.L.C.

High Precision Drive Components

PO Box 829 • 222 Industrial Way West • Eatontown, NJ 07724
Toll Free: 1-888-463-1400 • Tel: 732-460-9500 • Fax: 732-542-6725
www.brecoflex.com • e-mail: info@brecoflex.com

Copyright 2007 BRECO *flex* CO., L.L.C. • BRECO®, BRECOFLEX® & ATN® are registered trademarks of BRECO Antriebstechnik GmbH
ARC-POWER® is a registered trademark of BRECO *flex* CO., L.L.C. • Kevlar® is a registered trademark of DuPont
Patents Pending. Specifications are subject to change without prior notice.